

# Impact Wrenches

## Air



Bolting



### 2100 MAX Series



#### MAINTENANCE DUTY

- Titanium hammer case
- Cast aluminum hammer case (2015/25 MAX)
- Composite housing
- Reverse-biased motor
- Twin hammer mechanism
- Jumbo hammer mechanism (2015/25 MAX)
- 1/4" NPT inlet

Model	Description	Details	Handle	1 min.		Max ft-lbs		lb (kg)	in (mm)	in (mm)	in (mm)	cfm
				rpm	ft-lb (Nm)	ft-lb (Nm)	in (mm)					
2015MAX	3/8" Square at 90°	Hog-ring	Straight	7,100	2,100	F: 150 (203) R: 180 (244)	F: 45 - 140 (61 - 190) R: 45 - 160 (61 - 217)	3.4 (1.54)	13.1 (332)	1.1 (28)	3/8 (10)	19 (538)
2025MAX	1/2" Square at 90°	Hog-ring	Straight	7,100	2,100	F: 150 (203) R: 180 (244)	F: 45 - 140 (61 - 190) R: 45 - 160 (61 - 217)	3.4 (1.54)	13.1 (332)	1.1 (28)	3/8 (10)	19 (538)
2115TiMAX-AP	3/8" Square	Hog-ring	Pistol	15,000	1,500	F: 250 (339) R: 300 (407)	F: 25 - 230 (34 - 312) R: 55 - 280 (75 - 300)	2.48 (1.12)	5.95 (151)	1.1 (28)	3/8 (10)	17 (481)
2115QTiMAX-AP	3/8" Square	Hog-ring, Quietool	Pistol	15,000	1,500	F: 250 (339) R: 300 (407)	F: 25 - 230 (34 - 312) R: 55 - 280 (75 - 300)	2.48 (1.12)	5.95 (151)	1.1 (28)	3/8 (10)	17 (481)
2115PTiMAX-AP	3/8" Square	Pin Retainer	Pistol	15,000	1,500	F: 250 (339) R: 300 (407)	F: 25 - 230 (34 - 312) R: 55 - 280 (75 - 300)	2.48 (1.12)	5.95 (151)	1.1 (28)	3/8 (10)	17 (481)
2125QTiMAX-AP	1/2" Square	Hog-ring, Quietool	Pistol	15,000	1,500	F: 277 (375) R: 332 (450)	F: 25 - 251 (34 - 340) R: 76 - 302 (103 - 410)	2.51 (1.14)	6.1 (155)	1.1 (28)	3/8 (10)	17 (481)
2125PTiMAX-AP	1/2" Square	Pin Retainer	Pistol	15,000	1,500	F: 277 (375) R: 332 (450)	F: 25 - 251 (34 - 340) R: 76 - 302 (103 - 410)	2.51 (1.14)	6.1 (155)	1.1 (28)	3/8 (10)	17 (481)
2135TiMAX-AP	1/2" Square	Hog-ring	Pistol	9,800	1,250	F: 600 (813) R: 780 (1054)	F: 50 - 550 (68 - 746) R: 150 - 650 (203 - 880)	3.95 (1.79)	7.35 (186.7)	1- 3/8 (35)	3/8 (10)	24 (680)
2135QTiMAX-AP	1/2" Square	Hog-ring, Quietool	Pistol	9,800	1,250	F: 600 (813) R: 780 (1054)	F: 50 - 550 (68 - 746) R: 150 - 650 (203 - 880)	3.95 (1.79)	7.35 (186.7)	1- 3/8 (35)	3/8 (10)	24 (680)
2135PTiMAX-AP	1/2" Square	Pin Retainer	Pistol	9,800	1,250	F: 600 (813) R: 780 (1054)	F: 50 - 550 (68 - 746) R: 150 - 650 (203 - 880)	3.95 (1.79)	7.35 (186.7)	1- 3/8 (35)	3/8 (10)	24 (680)
2135OPTiMAX-AP	1/2" Square	Pin Retainer, Quietool	Pistol	9,800	1,250	F: 600 (813) R: 780 (1054)	F: 50 - 550 (68 - 746) R: 150 - 650 (203 - 880)	3.95 (1.79)	7.35 (186.7)	1- 3/8 (35)	3/8 (10)	24 (680)

Note: 2" extended anvil models: 2135Ti-2MAX-AP & 2135QTi-2MAX-AP

# Impact Wrenches

## Air



Bolting

1/4" QC,  
3/8" & 1/2"



### 1702 Series











1702P1



1702SB1

**HEAVY DUTY**

- Jumbo hammer mechanism
- Steel hammer case
- Pressure-fed mechanism lubrication
- 1/4" NPT inlet

Model	Description	Details	Handle	 1 min.	 1 min	 Max. ft-lbs	 ft-lbs	 lb (kg)	 in (mm)	 in (mm)	 in (mm)	 cfm
				rpm		ft-lb (Nm)	ft-lb (Nm)	lb (kg)	in (mm)	in (mm)	in (mm)	cfm
1702P1	3/8" square	Pin Retainer	Pistol	10,000	1,500	125 (170)	20 - 100 (27 - 136)	2.75 (1.25)	5.5 (140)	1.38 (34)	5/16 (8)	15 (425)
1702P4	1/4" hex	Pin Retainer	Pistol	10,000	1,500	125 (170)	20 - 100 (27 - 136)	2.75 (1.25)	5.5 (140)	1.38 (35)	5/16 (8)	15 (425)
1702SB1	3/8" square	Pin Retainer	Straight	10,000	1,500	105 (142)	13 - 85 (18 - 115)	2.5 (1.12)	5.88 (149)	1 (25)	5/16 (8)	13 (368)

### 2700 Series











2705P1



2707P1

**HEAVY DUTY**

- Twin hammer mechanism
- Steel hammer case
- Pressure-fed mechanism lubrication
- 1/4" NPT inlet

Model	Description	Details	Handle	 1 min.	 1 min	 Max. ft-lbs	 ft-lbs	 lb (kg)	 in (mm)	 in (mm)	 in (mm)	 cfm
				rpm		ft-lb (Nm)	ft-lb (Nm)	lb (kg)	in (mm)	in (mm)	in (mm)	cfm
2705P1	1/2" square	Pin Retainer	Pistol	8,500	1,200	400 (542)	40 - 250 (54 - 271)	5.63 (2.55)	6.75 (171)	1.38 (34)	3/8 (10)	23 (651)
2707P1	1/2" hex	Pin Retainer	Pistol	7,750	1,300	450 (610)	40 - 275 (54 - 373)	6 (2.72)	6.5 (165)	1.38 (34)	3/8 (10)	26 (736)

# Impact Wrenches

## Air



Bolting



3/8" & 1/2"

### 2900 Series



2902P1



2906P1

#### SUPER DUTY

- Steel hammer case
- Jumbo hammer mechanism (2902P1)
- Twin hammer mechanism (2906P1)
- Pressure-fed mechanism lubrication
- Integral muffler
- 1/4" NPT inlet

Model	Description	Details	Handle	1 min.		Max. ft-lbs		lb (kg)	in (mm)		in (mm)	cfm
				rpm	ft-lb (Nm)	ft-lb (Nm)	in (mm)		in (mm)			
2902P1	3/8" square	Pin Retainer	Pistol	10,000	1,500	180 (244)	20 - 150 (27 - 204)	2.5 (1.25)	5.5 (140)	1.38 (35)	3/8 (10)	15 (425)
2906P1	1/2" square	Pin Retainer	Pistol	5,000	1,200	500 (678)	40 - 350 (54 - 475)	6 (2.72)	6.88 (175)	1.34 (34)	3/8 (10)	23 (651)

### Tune-up kits

Part Number	For Use With
<b>3/8" &amp; 1/2" IMPACTOOL</b>	
2015-TK	2015/25 MAX
2115-TK2	2115/25 MAX
2135-TK2	2135 MAX
1702SB-TK2	1702SB1
1702P-TK2	1702P1, 2902P1
2705-TK3	2705P1
2707-TK2	2707P1
2906P-TK1	2906P1

### Hammer kits

Part Number	For Use With
<b>3/8" &amp; 1/2" IMPACTOOL</b>	
2015-THK	2015/25 MAX
2115-THK2	2115/25 MAX
2135-THK1	2135TiMAX 2135QTiMAX
2135PTi-THK1	2135PTiMAX 2135QPTiMAX

Note: Ingersoll Rand lubricants and greases are available to fulfill maintenance needs.

### Anvils & hangers

Part Number	Description	For Use With
<b>3/8" &amp; 1/2" IMPACTOOL</b>		
1702-A926-4	1/4" hex quick change anvil assembly	1702/2902 Series
2U-A925-4	Quick change chuck for 1/4" hex shank accessories	1702/2902 Series
1702-A926-7	7/16" hex quick change anvil assembly	1702/2902 Series
502-A925-7	Quick change chuck for 7/16" hex shank accessories	1702/2902 Series
705-A926-7	7/16" hex quick change anvil assembly	2906P1
1901-365	Vertical hanger	1702SB1
2908-365	Vertical hanger	2906P1
1901-366	Horizontal hanger	1702SB1
2706-366	Horizontal hanger	2707P1
904-366	Horizontal hanger	2906P1
2U-215	Socket adapter (3/8" to 1/2")	1702SB1



# Impact Wrenches

## Air



3/4" & 1"



Bolting

### 2100 Series



**MAINTENANCE DUTY**

- Steel hammer case
- Composite housing (2145Series, 2155QiMAX)
- Twin hammer mechanism
- Jumbo hammer mechanism (2161, 2171P)
- 3/8 NPT inlet

Model	Description	Details	Handle	1min. rpm	1min. rpm	Max. ft-lbs ft-lb (Nm)	ft-lbs ft-lb (Nm)	lb (kg)	in (mm)	in (mm)	in (mm)	cfm
2145QiMAX-AP	3/4" square Reverse bias motor	Hog-ring & Through-hole socket retainer	Pistol	7,000	1,150	F: 1,100 (1492) R: 1,350 (1830)	F: 200 - 900 (272 - 1220) R: 200 - 1000 (272 - 1356)	7.4 (3.4)	8.5 (217)	1.6 (41.5)	1/2 (13)	32 (906)
2155QiMAX	1" square Reverse bias motor	Hog-ring & Through-hole socket retainer	Pistol	7,000	1,150	F: 1,100 (1492) R: 1,350 (1830)	F: 200 - 900 (272 - 1220) R: 200 - 1000 (272 - 1356)	7.4 (3.4)	8.8 (225)	1.6 (41.5)	1/2 (13)	32 (906)
2161XP	3/4" square	Hog-ring	Pistol	6,000	1,025	1,250 (1695)	300 - 1,000 (407 - 1360)	12.14 (5.5)	8.3 (210)	1.75 (44)	1/2 (13)	46 (1303)
2161P	3/4" square	Through-hole socket retainer	Pistol	6,000	1,025	1,250 (1695)	300 - 1,000 (407 - 1360)	12.14 (5.5)	8.3 (210)	1.75 (44)	1/2 (13)	46 (1303)
2171XP	1" square	Hog-ring	Pistol	6,000	1,025	1,250 (1695)	300 - 1,000 (407 - 1360)	12.32 (5.6)	8.5 (216)	1.75 (44)	1/2 (13)	46 (1303)
2171P	1" square	Through-hole socket retainer	Pistol	6,000	1,025	1,250 (1695)	300 - 1,000 (407 - 1360)	12.32 (5.6)	8.5 (216)	1.75 (44)	1/2 (13)	46 (1303)

Note: 1) 3" extended anvil models: 2145QiMAX-3  
2) 6" extended anvil models: 2145QiMAX-6, 2161XP-6 & 2171XP-6

### 1700 Series



**HEAVY DUTY**

- Steel hammer case
- Jumbo hammer mechanism
- Pressure-feed mechanism lubrication
- Integral muffler
- 3/8" inlet
- 1" drive x 6" extended anvil for 1712B2 (Part#280-726-6)

Model	Description	Details	Handle	1min. rpm	1min. rpm	Max. ft-lbs ft-lb (Nm)	ft-lbs ft-lb (Nm)	lb (kg)	in (mm)	in (mm)	in (mm)	cfm
1720P1	3/4" square	Through-hole socket retainer	Pistol	5,500	1,000	1,000 (1360)	200 - 600 (271 - 814)	12.54 (5.65)	7.63 (194)	1.91 (48)	1/2 (13)	40 (1133)
1720P3	1" square	Through-hole socket retainer	Pistol	5,500	1,100	1,100 (1491)	250 - 750 (339 - 1017)	12.54 (5.65)	7.63 (194)	1.91 (48)	1/2 (13)	40 (1133)
1720B1	3/4" square	Through-hole socket retainer	Grip I.T.	5,500	1,000	1,000 (1360)	200 - 600 (271 - 814)	13.87 (6.29)	11.75 (299)	1.91 (48)	1/2 (13)	40 (1133)
1720B3	1" square	Through-hole socket retainer	Grip I.T.	5,500	1,000	1,100 (1491)	250 - 750 (339 - 1017)	13.87 (6.29)	11.75 (299)	1.91 (48)	1/2 (13)	40 (1133)
1712B2	1" square	Through-hole socket retainer	Grip I.T.	6,000	800	1,350 (1898)	450 - 1,000 (610 - 1356)	18.25 (8.28)	11.25 (286)	2.19 (56)	3/4 (19)	47 (1331)

Note: 1) Crip-straight/inline shape  
2) I.T.-Inside Trigger

# Impact Wrenches

## Air



Bolting



3/4" & 1"

## 2920 Series



2920B9



2920B1

**SUPER DUTY**

- Steel hammer case
- Twin hammer mechanism
- Pressure-fed mechanism lubrication
- Integral muffler
- 3/8" NPT inlet
- 6" Extended anvil as option (part#2910B-726-6)

Model	Description	Details	Handle	1 min.		Max. ft-lbs		lb (kg)	in (mm)	in (mm)	in (mm)	cfm
				rpm	ft-lb (Nm)	ft-lb (Nm)	ft-lb (Nm)					
2920B1	3/4" square	Through-hole socket retainer	Grip I.T.	5,000	950	1,100 (1492)	250 - 800 (339 - 1085)	13.19 (5.98)	12.5 (318)	1.91 (49)	1/2 (13)	36 (1020)
2920B9	3/4" square at 90°	Through-hole socket retainer	Grip I.T.	5,000	950	550 (746)	125 - 400 (170 - 542)	23.69 (10.75)	17.5 (445)	1.31 (33)	1/2 (13)	36 (1020)

Note: 1) Grip-straight/inline shape  
2) I.T.-Inside Trigger  
3) O.T.-Outside Trigger

## 2925Ti Series



2925P1Ti



2925B2Ti

**SUPER DUTY**

- Titanium hammer case
- Corrode-X™ component package
- Twin hammer mechanism
- Choice of balanced or reversed bias motor
- Pressure-fed mechanism lubrication
- Integral muffler
- 3/8" NPT inlet

Model	Description	Details	Handle	1 min.		Max. ft-lbs		lb (kg)	in (mm)	in (mm)	in (mm)	cfm
				rpm	ft-lb (Nm)	ft-lb (Nm)	ft-lb (Nm)					
2925P1Ti	3/4" square	Through-hole socket retainer	Pistol	5,200	1,050	1,450 (1966)	350 - 1,100 (475 - 1492)	12 (5.44)	8.9 (225)	1.75 (44)	1/2 (13)	60 (1699)
2925RBP1Ti	3/4" square reverse bias	Through-hole socket retainer	Pistol	5,200	1,050	F: 1,300 (1763) R: 1,600 (2169)	F: 300 - 950 (407 - 1288) R: 400 - 1,400 (542 - 1898)	12 (5.44)	8.9 (225)	1.75 (44)	1/2 (13)	60 (1699)
2925B2Ti	1" square	Through-hole socket retainer	Grip I.T.	6,500	900	1,600 (2169)	350 - 1,250 (475 - 1695)	15.2 (6.89)	13.28 (334)	1.75 (44)	1/2 (13)	60 (1699)
2925RB2Ti	1" square reverse bias	Through-hole socket retainer	Grip I.T.	6,500	900	F: 1,500 (2333) R: 1,700 (2304)	F: 300 - 950 (407 - 1288) R: 400 - 1,400 (542 - 1898)	15.2 (6.89)	13.28 (334)	1.75 (44)	1/2 (13)	60 (1699)
2925P3Ti	1" square	Through-hole socket retainer	Pistol	5,200	1,050	1,450 (1966)	350 - 1,100 (475 - 1492)	12.2 (5.54)	9.04 (230)	1.74 (44)	1/2 (13)	60 (1699)
2925RBP3Ti	1" square reverse bias	Through-hole socket retainer	Pistol	5,200	1,050	F: 1,300 (1763) R: 1,600 (2169)	F: 300 - 950 (407 - 1288) R: 400 - 1,400 (542 - 1898)	12.2 (5.54)	9.04 (230)	1.74 (44)	1/2 (13)	60 (1699)

# Impact Wrenches

## Air



Bolting

### 2934 & 2940 Series



**2934P2**



**2934A2 (O.T.-Outside Trigger)  
2934B2**

**SUPER DUTY**

- Cast iron hammer case
- Bronze endplates
- Twin hammer mechanism
- Pressure-fed mechanism lubrication
- Integral muffler
- 1/2" NPT inlet

Model	Description	Details	Handle	1 min.		Max ft-lbs		lb (kg)	L		Ø	cfm
				rpm	ft-lb (Nm)	ft-lb (Nm)	in (mm)		in (mm)			
2934B2	1" square	Through-hole socket retainer	Grip I.T.	6,600	750	1,500 (2034)	500 – 1,100 (678 – 1491)	18.5 (8.39)	11.25 (286)	2.19 (56)	3/4 (19)	47 (1331)
2934B9	1" square at 90°	Through-hole socket retainer	Grip I.T.	5,300	780	750 (1017)	250 – 500 (339 – 678)	35.75 (16.2)	18.63 (473)	1.63 (41)	3/4 (19)	47 (1331)
2934P2	1" square	Through-hole socket retainer	Pistol	5,300	825	1,500 (2034)	500 – 1,100 (678 – 1491)	20 (9.07)	8.63 (219)	2.19 (56)	3/4 (19)	47 (1331)
2940B2	1" square	Through-hole socket retainer	Grip I.T.	5,000	850	2,000 (2,710)	1,000-1,600 (1360-2169)	22 (9.98)	12.25 (311)	2.19 (56)	3/4 (19)	58 (1643)
2940P2	1" square	Through-hole socket retainer	Pistol	4,000	810	2,000 (2,710)	1,000-1,600 (1360-2169)	22.88 (10.40)	9.88 (251)	2.19 (56)	3/4 (19)	58 (1643)

Note: 1) #5 spline models-2940B1 (I.T.) & 2940A1 (O.T.)  
2) Grip O.T.Model-2940A2

### 3940Ti Series



**3940P2Ti**



**3940B2Ti**

**SUPER DUTY**

- Titanium hammer case
- Bronze endplates
- Twin hammer mechanism
- Reverse bias motor
- Pressure-fed mechanism lubrication
- Integral muffler
- 1/2" NPT inlet

Model	Description	Details	Handle	1 min.		Max ft-lbs		lb (kg)	L		Ø	cfm
				rpm	ft-lb (Nm)	ft-lb (Nm)	in (mm)		in (mm)			
3940A1Ti	No. 5 spline	Through-hole socket retainer	Grip O.T.	6,000	800	2,500 (3390)	F: 500 – 1,650 (680 – 2240) R: 500 – 1,800 (680 – 2440)	21.2 (9.6)	13.4 (341)	2.3 (59)	3/4 (19)	75 (2124)
3940A2Ti	1" square	Through-hole socket retainer	Grip O.T.	6,000	800	2,500 (3390)	F: 500 – 1,650 (680 – 2240) R: 500 – 1,800 (680 – 2440)	21.2 (9.6)	13.4 (341)	2.3 (59)	3/4 (19)	75 (2124)
3940B1Ti	No. 5 spline	Through-hole socket retainer	Grip I.T.	6,000	800	2,500 (3390)	F: 500 – 1,650 (680 – 2240) R: 500 – 1,800 (680 – 2440)	21.2 (9.6)	13.4 (341)	2.3 (59)	3/4 (19)	75 (2124)
3940B2Ti	1" square	Through-hole socket retainer	Grip I.T.	6,000	800	2,500 (3390)	F: 500 – 1,650 (680 – 2240) R: 500 – 1,800 (680 – 2440)	21.2 (9.6)	13.4 (341)	2.3 (59)	3/4 (19)	75 (2124)
3940P2Ti	1" square	Through-hole socket retainer	Pistol	5,300	800	2,500 (3390)	F: 500 – 1,650 (680 – 2240) R: 500 – 1,800 (680 – 2440)	20.4 (9.3)	10.1 (256)	2.3 (59)	3/4 (19)	75 (2124)

# Impact Wrenches

## Air



Bolting



### 3942Ti Series



- SUPER DUTY**
- Titanium hammer case
  - Bronze endplates
  - Twin hammer mechanism
  - Reverse bias motor
  - Pressure-fed mechanism lubrication
  - Integral muffler
  - 1/2" NPT inlet

Model	Description	Details	Handle	1 min. rpm	1 min. ft-lb (Nm)	Max. ft-lb (Nm)	ft-lb (Nm)	lb (kg)	in (mm)	in (mm)	in (mm)	cfm
3942A2Ti	1" square	Through-hole socket retainer	Grip O.T.	5,000	850	3,250 (4406)	F: 1,000 – 1,950 (1356 – 2644) R: 1,000 – 2,100 (1356 – 2848)	22.6 (10.5)	14.2 (361)	2.3 (59)	3/4 (19)	95 (2690)
3942B1Ti	No. 5 spline	Through-hole socket retainer	Grip I.T.	5,000	850	3,250 (4406)	F: 1,000 – 1,950 (1356 – 2644) R: 1,000 – 2,100 (1356 – 2848)	22.6 (10.5)	14.2 (361)	2.3 (59)	3/4 (19)	95 (2690)
3942B2Ti	1" square	Through-hole socket retainer	Grip I.T.	5,000	850	3,250 (4406)	F: 1,000 – 1,950 (1356 – 2644) R: 1,000 – 2,100 (1356 – 2848)	22.6 (10.5)	14.2 (361)	2.3 (59)	3/4 (19)	95 (2690)

### Tune-up kits

Part Number	For Use With
<b>3/4" TO 1-1/2" IMPACT TOOL</b>	
2145-TK2	2145 Series
2161-TK2	2161XP, 2161P 2171XP, 2171P
1720B-TK2	1720B1, 1720B3
1720P-TK2	1720P1, 1720P3
1712B/1712P-TK3	1712B2
2920B-TK2	2920B Series
2925B-TK2	2925Ti Series
2934-TK3	2934 Series
2940-TK3	2940 Series
2945-TK2	2945 Series
2950-TK2	2950 Series
3940-TK1	3940Ti Series
3942-TK1	3942Ti Series
3955-TK1	3955Ti Series

### Anvils, Hangers & Exhaust Kit

Part Number	Description	For Use With
<b>3/4" &amp; 1" IMPACT TOOL</b>		
1712-A526	Spline drive anvil assembly	1712B2
2910B-A926-10	Quick change anvil assembly	2920 Series
2910-A526	#4 spline drive anvil assembly	2920 Series & 2925 Series
2934-A526	Spline drive anvil assembly	2934 Series
2161-366	Horizontal hanger	2161/71 & 2925Ti Series
910-366	Horizontal hanger	1720/2920 Series
2934-366	Horizontal hanger	1712B2 & 2934 & 2940 Series
2934-314-6	1" x 6" extended anvil	2934 Series
2940-314-6	1" x 6" extended anvil & hammer kits	2940 Series
2161-123	Piped-away exhaust kit	2925 & 2161P
2940-K184	Piped-away exhaust kit	2934/2940/ 2945 & 2950 Series



Note: Ingersoll Rand lubricants & greases are available to fulfill maintenance needs. Refer to Parts Lists for details.

# Impact Wrenches

## Air



1-1/2" - 3-1/2"



Bolting

## 2950 & 3955Ti Series



**SUPER DUTY**

- Plated iron hammer case (2950 Series)
- Titanium hammer case (3955 Series)
- Bronze endplates (3955 Series)
- Twin hammer mechanism
- Reverse bias motor (3955 Series)
- Pressure-fed mechanism lubrication
- Integral muffler
- 1/2" NPT inlet
- Durable epoxy-coated handle/housing (2950 Series)

Model	Description	Details	Handle	1 min.	1 min.	Max ft-lbs	ft-lbs	lb (kg)	in (mm)	in (mm)	in (mm)	cfm
3955A2Ti	1-1/2" square	Through-hole socket retainer	Grip O.T.	2,750	700	5,000 (6779)	F: 1,600 - 3,900 (2169 - 5288) R: 1,600 - 4,150 (2170 - 5630)	34.6 (15.7)	16.65 (423)	2.67 (68)	3/4 (19)	80 (2265)
3955B1Ti	No. 5 spline	Through-hole socket retainer	Grip I.T.	2,750	700	5,000 (6779)	F: 1,600 - 3,900 (2169 - 5288) R: 1,600 - 4,150 (2170 - 5630)	34.6 (15.7)	16.65 (423)	2.67 (68)	3/4 (19)	80 (2265)
3955B2Ti	1-1/2" square	Through-hole socket retainer	Grip I.T.	2,750	700	5,000 (6779)	F: 1,600 - 3,900 (2169 - 5288) R: 1,600 - 4,150 (2170 - 5630)	34.6 (15.7)	16.65 (423)	2.67 (68)	3/4 (19)	80 (2265)
2950B7	1-1/2" square	Through-hole socket retainer	Grip I.T.	3,750	650	3,000 (4067)	1,600-2,500 (2170-3390)	32.63 (14.8)	14.5 (368)	2.5 (64)	3/4 (19)	70 (1982)

## 5000 Series

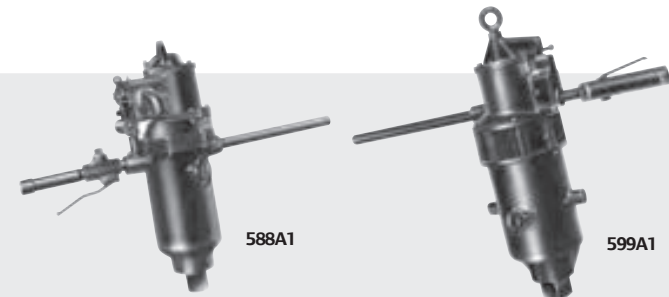

**SUPER DUTY**

- Cast aluminum hammer case (5980A1, 5982A1)
- Cast iron hammer case (588A1, 599A1)
- Precision ball and cam mechanism
- Built-in lubricator
- Lever throttle
- Dead handle
- Vertical and horizontal hangars

Model	Description	Details	Handle	1 min.	1 min.	Max ft-lbs	ft-lbs	lb (kg)	in (mm)	in (mm)	in (mm)	cfm
5980A1	1-1/2" square	3/4" NPT Inlet	Lever	830	1,000	10,000 (13560)	2,300 - 5,500 (3119 - 7460)	88 (39.9)	23 (584)	3.06 (78)	1 (25)	138 (3908)
5982A1	2-1/2" square	3/4" NPT Inlet	Lever	830	850	20,000 (27120)	4,000 - 10,000 (5424 - 13560)	120 (54.5)	25.38 (645)	3.5 (90)	1 (25)	130 (3681)
588A1	2-1/2" square	1" NPT Inlet	Lever	355	550	50,000 (67800)	12,000 - 25,000 (16270 - 33900)	215 (97.5)	26.63 (676)	4 (101)	1 (25)	155 (4389)